***Reverse Osmosis
Drinking Water System
Installation, Operation and Service Manual***

TABLE OF CONTENTS

Introduction	1
Product Specifications & Application Guidelines	2
Functional Description	2
Your New Reverse Osmosis System (supplied items checklist)	2
Carton Contents & Assembly.....	3
Installation.....	4
Startup and Operation.....	8
Maintenance	9
Sanitization Procedures.....	10
Maintenance Schedule	13
Parts List and Drawing for E75TFC-3SF / E50TFC-3SF	14
Reverse Osmosis Drinking Water System Flow Diagram (all models)	15
Troubleshooting Guide.....	16
Reverse Osmosis Accessories	17
Warranty Information & Addresses	18

IMPORTANT WARNING - PLEASE READ

System Flushing: This reverse osmosis system contains a preservative solution to prevent microbiological growth and freezing which if ingested may cause irritation of the gastrointestinal tract, colic, diarrhea or other symptoms. Therefore, approximately 5 gallons of water must be drawn from the tap to flush out the preservative solution before using the system. This volume of water represents approximately two days of production. The water flushed should be disposed of to the drain.

Feed Water Quality: This reverse osmosis drinking water system is not intended to be used for the treatment of water that is microbiologically unsafe or of unknown quality. If the feed water quality is unsafe or unknown, have a sample of the water tested by a qualified laboratory or agency and implement the necessary measures to ensure a safe water supply.

INTRODUCTION

Congratulations, on the purchase of your new Reverse Osmosis Drinking Water System. Treated with care and regular maintenance, your new system will provide many years of service delivering purified water to the tap.

By now, you have probably already opened the box to survey the contents. Please take a few moments to review this manual before proceeding with the installation and use of the system. Some important items to review are as follows:

- Check all components for any damage caused in shipment. Also, take a quick inventory of all items supplied to ensure none are missing. A checklist in the next section will assist you with identifying these items.
- Ensure that the reverse osmosis system and storage tank will easily fit into the desired location. This reverse osmosis system and tank needs to be removed for regular maintenance, so good accessibility is an important tip to keep in mind.
- Read all warnings contained within this manual.

Although this product is described as a *'Drinking Water System'*, the purified water produced by the reverse osmosis (RO) process can be used for many purposes around the home.

- **Drinking Water** - keep container of RO water in the fridge to be able to enjoy the clean, fresh taste. Alternatively, take it directly from the tap.
- **Ice Cubes** - use RO water to fill ice cube trays. Ice cubes made from RO water are typically clearer and better tasting than ice made from plain tap water.
- **Automatic Ice Makers** - a water line from the RO system can be plumbed to refrigerators with automatic icemakers. Additional accessories required to complete this connection are not included. Please consult the refrigerator's owner's manual on this installation.
- **Kettles and Coffee Makers** - plain tap water eventually causes films and scale in these devices that is difficult to clean. RO water is very low in dissolved minerals content, greatly reducing the chance of scale buildup.
- **Cooking** - use RO water for boiling pasta, rice or any other recipe that calls for water in the instructions.
- **Washing Fresh Fruit & Vegetables** - prevent tap water minerals from being deposited onto food to maintain freshness.
- **Family Pets** - Allow your dog or cat to enjoy the same purified water you do.
- **Irons and Steamers** - prevent mineral buildup in household appliances that use water and eventually build up with scale when using plain tap water.

Now you can relax and enjoy the benefits of great tasting water supplied by your reverse osmosis drinking water system. Remember that good quality water is important to maintaining a healthy lifestyle. You can also feel good about the money you have saved by installing your own drinking water system instead of dealing with the expense and hassle of bottled water delivery.

Application Guidelines

Model Number	Membrane Type	Max. Feed Water Salinity	Feed Water Temperature	Feed Water Pressure	Feed Water pH	Feed Water Supply	Feed Water Hydrogen Sulphide	Feed Water Manganese	Feed Water Iron	Feed Water Hardness
E50TFC-3	TFC	2000 ppm	40-110°F	50-100 psi	2.0-11.0	Chlorinated Unchlorinated	None	<0.05 ppm	<0.1 ppm	<10 gpg
E75TFC-3	TFC	2000 ppm	40-110°F	50-100 psi	2.0-11.0	Chlorinated Unchlorinated	None	<0.05 ppm	<0.1 ppm	<10 gpg

Specifications

Model Number	Membrane Production Rate ⁽¹⁾	Rejection ⁽²⁾	Storage Tank Capacity US Gal
E50TFC-3SF	50 USGPD	up to 99%	4.0
E75TFC-3SF	75 USGPD	up to 99%	4.0

⁽¹⁾ Nominal product water ratings are based on the following conditions: Supply TDS of 250 ppm softened tap water, 50 psi (0.36 Mpa), 77°F (25°C), pH 8 and 15% recovery with outlet to atmosphere.

⁽²⁾ Rejection percentages are dependent on the supply conditions and the substance being measured.

Notes: The performance of a reverse osmosis membrane is highly dependent upon pressure, temperature and TDS. The actual volume of product water and rejection percentage will vary with differences from the test conditions that membrane ratings are based upon.

These drinking water systems are not intended to be used for the treatment of water that is microbiologically unsafe or of unknown quality.

Functional Description

Feed water enters the 5-micron pre-filter, which filters out suspended particles such as dirt or sediment. The filtered water then enters the pre-carbon filter (3 sump models only), which contains granular activated carbon, which removes any chlorine from the water.

The water then enters the reverse osmosis membrane. The membrane will allow only permeate (product water) to pass through. The brine (waste water) goes to the drain.

Permeate then flows through a hydraulic shut-off valve to the storage tank. When the tank fills and the tank pressure reaches approximately 40% to 65% of the inlet feed water pressure, the shut-off valve closes, which turns the system off.

When water is drawn from the faucet, permeate flows from the storage tank through the post carbon filter. This filter contains granulated activated carbon, removing any taste and odor that has accumulated while stored in the tank. When the tank empties, the shut-off valve opens, turning the unit on.

Supplied Item Checklist

Out of the box, your new R.O. System should be supplied with the following items. If any items appear to be missing, please contact the distributor who sold the system.



Figure 1 - Supplied items for 3 sump models

1. Pressure tank & right angle shut-off valve with compression nut
2. Reverse Osmosis System
3. Reverse Osmosis membrane element, 5 micron pre-filter, pre-carbon filter, carbon filter (in individual sealed protective bags)
4. Filter sump wrench, drain line saddle assembly, tubing bundle, feed water saddle piercing valve, quick connect fitting; 3/8" tube x 1/8" FNPT
5. Faucet assembly

Carton Contents & Assembly

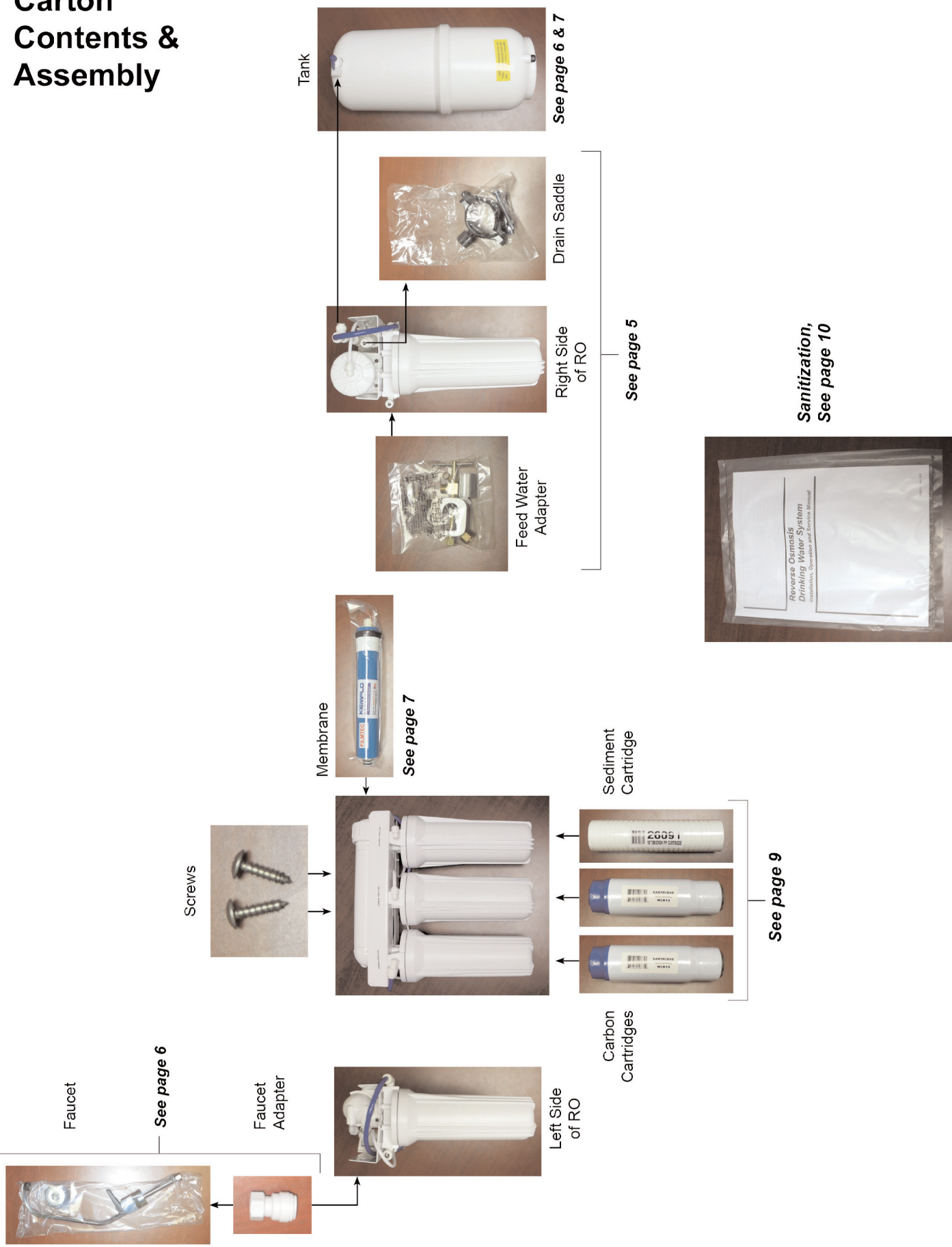

Installation

All State/Provincial and local government codes regarding installation of these devices must be observed.

Verify Water Supply is Potable

The water supply must meet provincial/state and/or national standards for potable drinking water. Water samples should be sent to a certified laboratory for analysis.

Placement of Components

Placement of the various components of the system will vary from installation to installation. The main objective is to place the components so that they are accessible for servicing and ease of installation.

Spigot

Proper faucet placement should ensure a no-splash waterfall pattern into the sink. The spigot handle should be positioned to either the left or right as one faces the sink.

Storage Tank

The storage tank should be placed so that it can be easily removed from under the sink. **Avoid placing the storage tank in out-of-the-way cabinets or dead spaces.** There are two reasons for this: 1) the difficulty of installation increases significantly and 2) when the storage tank is located further away from the faucet, the flow rate diminishes.

Module Assembly

The module assembly should be hung on a sink cabinet side-wall with the two wood screws.

Quick Connect Fittings

All connections are quick connect fittings except for the compression fitting at the inlet saddle valve, drain saddle valve and storage tank shutoff valve.

To Prepare Tubing

- Cut the tube squarely and remove any burrs.
- Mark from the end of the tube the length of insertion. (1/4" O.D. - 11/16", 3/8" O.D. - 3/4")

To Insert Tubing into Fitting

- Insert tube straight into fitting until it bottoms out on interior shoulder and insertion mark is no longer visible.

To Release Tubing

- Push collet toward body and pull on tubing to release tube. To re-use fitting, begin assembly over again.

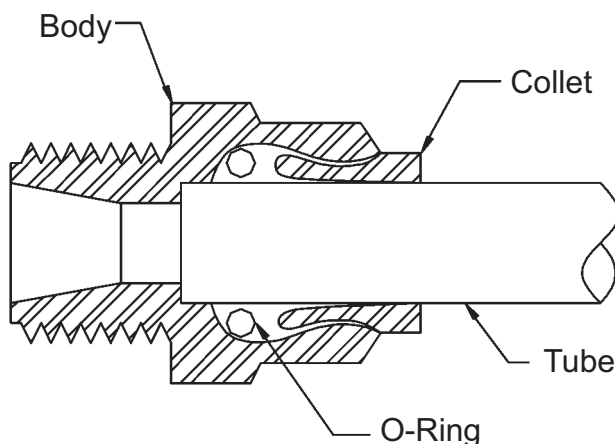

Figure 2 - Quick Connect Fitting

Installation of Feed Water Assembly

The system comes supplied with a saddle-type valve with mounting hardware and is intended to be used on 3/8" to 1/2" copper tubing cold water supply line. NOTE: It is not to be used on flex lines.

- a. Turn off cold water valve under the sink or main valve for the house.
- b. Slide the clamp over the copper tubing and tighten the bottom screw firmly to hold the clamp in position. (See Figure 3a & 3b)
- c. Slide brass nut, plastic sleeve and tube insert on to the green 1/4" plastic tubing and thread onto valve outlet.
- d. Pierce the copper tubing by turning the needle valve handle (clockwise) until it is firmly seated. The valve is closed in this position.
- e. Turn on main supply valve to pressurize cold water line. Immediately check for any signs of leaks.
- f. When ready to supply water to the system, turn valve handle (counter-clockwise) until fully open.

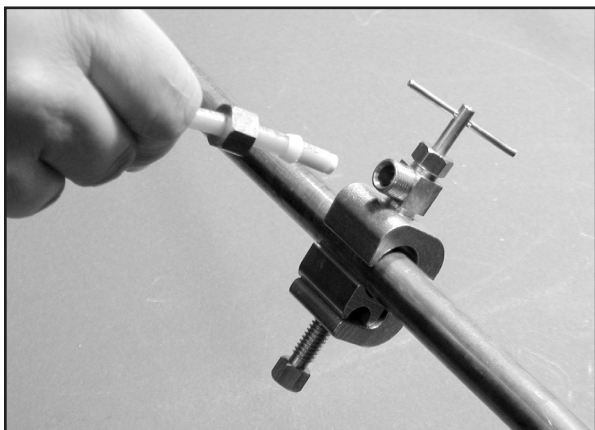

Figure 3a

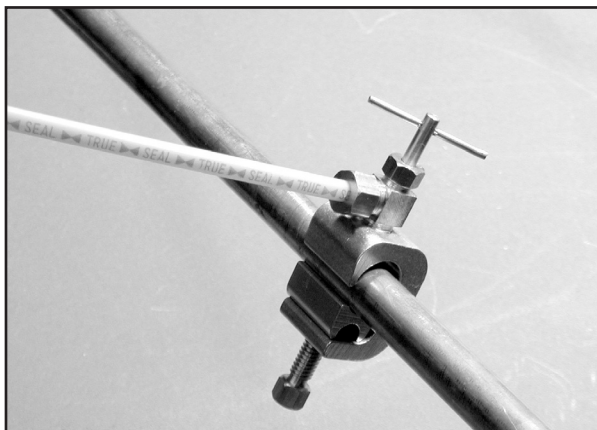

Figure 3b

Feed Water Assembly

Installation of Drain Saddle Assembly

The system comes supplied with a drain saddle and mounting hardware which fits around a standard 1 1/2" O.D. drain pipe (See Figure 4).

- a. The saddle should be installed above the trap and on the vertical or horizontal tailpiece. It should never be placed close to the outlet of a garbage disposal (See Figure 5).
- b. Position saddle assembly on drain pipe to allow adequate space for drilling through pipe. If possible, angle the drain saddle fitting toward spigot location.
- c. Tighten the drain saddle screws evenly and firmly so a good seal is made. Avoid over tightening.
- d. Drill a 5/16" hole in the drain pipe through the drain fitting opening. Support the drain against drilling pressure.
- e. Insert black drain line tubing into compression nut and tighten.



Figure 4 - Drain Saddle Assembly

NOTE: Some state or local codes may require that the drain saddle be served by a trap other than the one serving the garbage disposal. Before making a connection as shown in Figure 4, please check with code authorities.

Figure 5 - Recommended Drain Saddle Connections

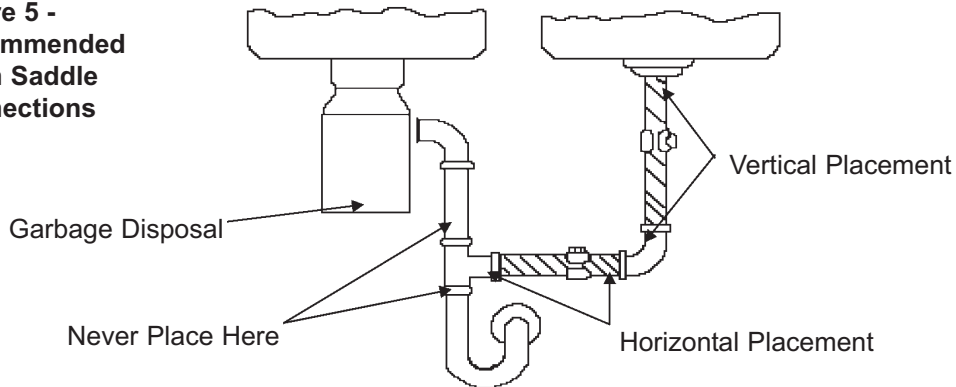

Installation of Ball Valve Assembly

The ball valve and quick connect adapter must be installed on the RO storage tank.

- a. Install the 1/4" x 3/8" male connector onto the ball valve. Tighten the fitting very gently until it is snug. *Be very careful not to over-tighten or the threads may strip.*
- b. Tighten the ball valve assembly onto the RO storage tank. Tighten the fitting very gently until it is snug. *Be very careful not to over-tighten or the threads may strip.*

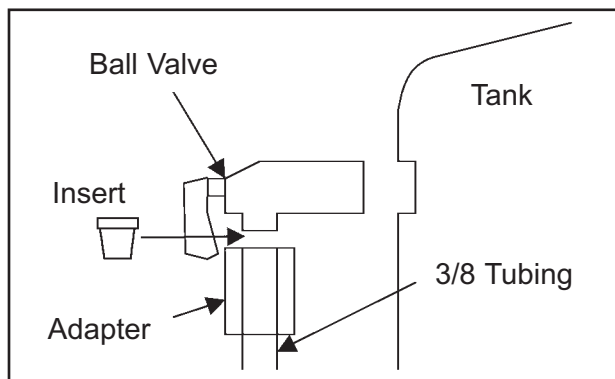

Figure 6 - Pressure Tank Shutoff Valve

Drilling Sink Hole

The typical 1-1/8" sink hole will accommodate the standard spigot. Once the location of the spigot has been determined, always check below the point you are about to drill to ensure it is unobstructed and that it isn't over a reinforcing rib.

- a. Center punch the desired location to provide a starting point for your drill.
- b. Drill a 1/8" pilot hole.
- c. Enlarge the pilot hole using a 9/16" drill bit for standard faucet.
- d. Remove all burrs and sharp edges.
- e. Immediately clean up the sink area.

NOTE: If an enamel or porcelain sink is encountered, it is very important that the layer of porcelain be removed before following the steps outlined above. This can be accomplished by gently grinding away, using a hobby grinder and silicon carbide wheel, enough area of porcelain down to the metal base to accommodate a 1-1/8" high speed steel hole saw. The hole saw cannot contact surrounding porcelain or chipping can occur. Now the steps outlined above can be followed.

Installation of Non-Air Gap Faucet

1. Place the chrome washer and the rubber washer on the base of the faucet.
2. Apply 5-7 wraps of the teflon tape to the bottom of the brass stem. Install 3/8" quick connect faucet adapter provided. Tighten gently until fitting is snug. Be careful not to over-tighten as the threads may strip.
3. Mount the faucet and complete assembly.

Installation of Filters

- A. Sump #1 - Sediment Pre-filter 5 micron Cartridge
- B. Sump #2 - Carbon Pre-filter Cartridge
- C. Sump #3 - Carbon Post-filter Cartridge

Installation of Membrane

Important: Keep the membrane and your hands clean in order to avoid bacterial contamination of the membrane.

1. Disconnect the hose on the end of the membrane housing end cap.
2. Unscrew the end-cap.
3. Hold the membrane upside down, cut the plastic bag at the bottom, and drain off any liquid.
4. The bottom tip of the membrane must seat firmly in the protruding female socket inside the membrane housing.
5. Without touching the membrane, slide it into the membrane housing and discard the plastic bag. With your thumb or the palm of your hand, push the membrane all the way into the housing.
Important: Do not use force, and ensure that the membrane is not protruding from the housing.
6. Replace the membrane housing end cap and hand tighten.
7. Push the tubing back into the quick connect fitting. Ensure the tubing is all the way in.



Sump #3 Sump #2 Sump #1

Figure 7 - Front View

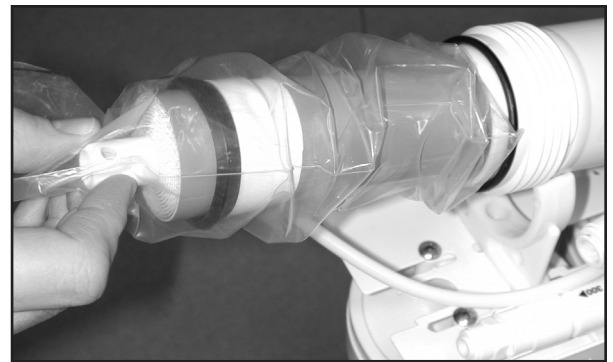
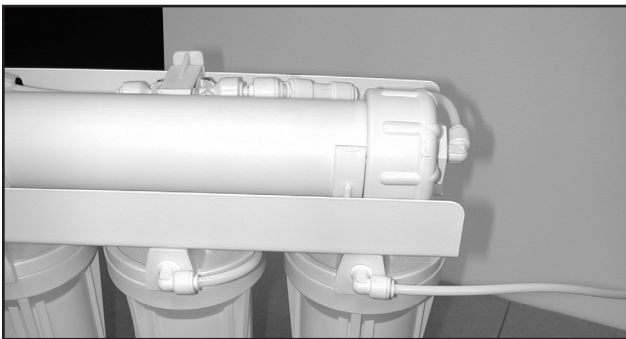
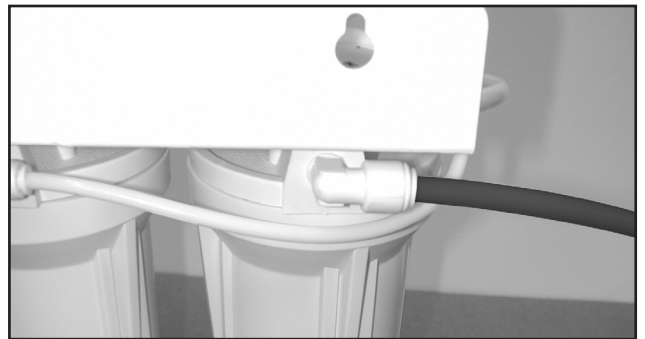

Figure 8 - Installing membrane without touching

Connecting Components



- a. Connect the 1/4" white tube from the (90° elbow) 5 micron pre-filter fitting to the fitting on the cold water supply line.



- b. Connect the 3/8" blue tube from the (90° elbow) granular activated carbon post-filter fitting to the quick connect fitting on the threaded pipe on the spigot.

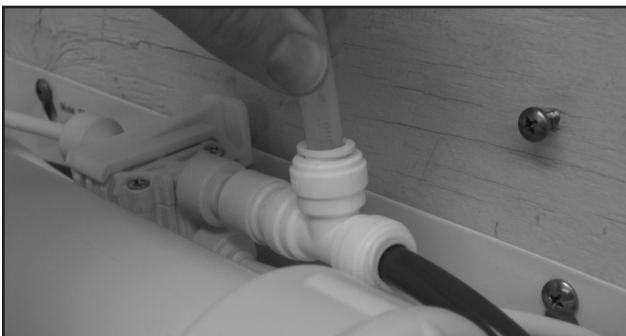

- c. Connect the 3/8" tube from the (male tee) granular activated carbon post-filter fitting to the fitting on the storage tank.

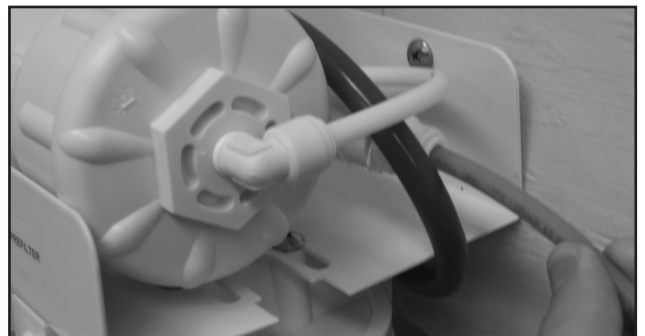

- d. **Standard Faucet** - Connect the 1/4" red tube to the drain fitting.

Start-Up Procedure

WARNING: To prevent microbiological growth and freezing, this reverse osmosis system contains a preservative solution which, if ingested, may cause irritation of the gastrointestinal tract, colic, diarrhea or other similar symptoms. Therefore, 5 gallons (approximately two full tanks) must be drawn from the spigot to flush out the preservative. This may represent two or three days of running, depending on conditions of the feed water.

The carbon filters require some rinsing to remove carbon fines. The filters will rinse out on their own by allowing the system to produce 2 full tanks of water and discarding the RO product water. The following procedure may be followed if it is desired to rinse the filters immediately before producing an RO product water.

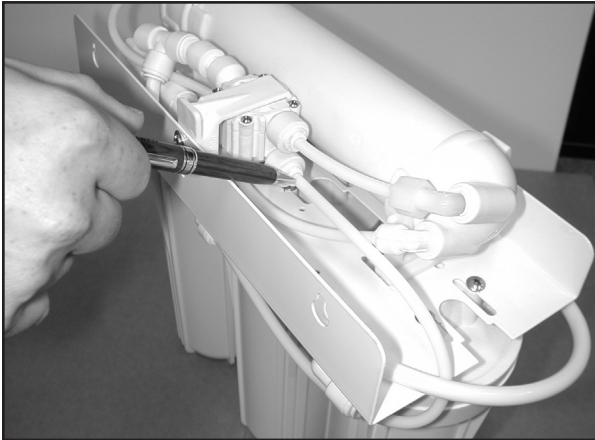

Figure 9 - Disconnect pre-carbon outlet tube from shutoff valve



Figure 10 - Direct flushed water and carbon fines into container

- a. Disconnect the line from the auto shut off valve that runs from the outlet side of the Pre-Carbon Filter to the Auto Shut Off Valve. Direct tubing into a pail or catch basin.
- b. Turn on the feed water by opening the needle valve on the feed water saddle valve and catch the water in the pail. The water rinsing the filter will appear grayish until the fines are rinsed out. When the water returns to clear, close the inlet water valve. Re-connect the white tubing back into the Auto Shut Off Valve. The filters are now rinsed.
- c. Turn on feedwater by opening the inlet water valve. Immediately check for any signs of a leak. Correct any problems if necessary. Turn on storage tank valve.
- d. It will not be uncommon to experience air bubbles or dissolved air in the product water. This will disappear after the unit is in service for a short period of time.
- e. The first two full tanks must be discarded to flush the membrane preservative out of the system as well as flush the carbon fines from the Post Carbon Filter.

Maintenance Schedule

This schedule is designed for the average potable water supply and should be followed to ensure the proper functioning of your drinking water system.

Pre-Filter - The pre-filter contains a 5 micron mechanical filter element. Its function is to remove suspended particles from the feed water, thus reducing the possibility of clogging the reverse osmosis membrane. The pre-filter element should be replaced every twelve months or earlier depending on the quality of the feed water.

Pre-Carbon Filter -The pre-filter contains a granular activated carbon. Its function is to remove chlorine from the incoming water to prevent any damage to the TFC membrane. The Pre-Carbon filter cartridge should be replaced every 24 months.

Reverse Osmosis Module - The reverse osmosis module contains a semi-permeable membrane. Its function is to separate water molecules from dissolved impurities in the feed water. This is accomplished by application of hydraulic pressure greater than the osmotic pressure in water containing dissolved solids. The life of the membrane can be determined by measuring the percentage of rejection of total dissolved solids in the water. The membrane should be replaced every 24 to 36 months when its efficiency will decrease.

Post-Carbon Filter - The post-filter contains a granular activated carbon. Its function is to remove any taste and odor from the water prior to delivering it to the spigot. The post-filter cartridge should be replaced every 24 months.

Changing Filters

Important: This RO System contains filters, which must be replaced at regular intervals to maintain proper performance. See Maintenance Schedule for the recommended interval for changing the filters. Local conditions may dictate more frequent cartridge replacement. Use a drip pan to catch any water that may spill when the housings are removed. Use only factory approved filters.

1. Close the saddle valve and open the faucet by lifting the handle. Allow storage tank to empty.
2. Loosen and remove the appropriate filter housing(s). Discard the cartridge(s).
3. Wash the inside of the housings using a mild detergent and a soft cloth. Do not use abrasive cleaners or pads. Thoroughly rinse all soap from the housing before re-assembly.



Figure 11 - Using sump wrench to change filter cartridges

Sanitization Procedures for your Reverse Osmosis System

Sanitization is a simple but important part of a regular maintenance routine required to keep your Reverse Osmosis Drinking Water System operating properly.

Recording the dates of all maintenance and sanitization done on the unit is a good idea as well as marking on your calendar future service interval dates. Your water system installer may have a maintenance service program to deal with cartridge replacement and system sanitization by setting up regular scheduled service calls.

Sanitization maintenance of the Reverse Osmosis Drinking Water System should be performed:

- Upon installation
- At least every 6 - 12 months as part of a regular maintenance routine.
- Whenever the pre-filter and post-filter cartridges are replaced as part of a regular maintenance routine.
- Whenever the reverse osmosis membrane is replaced.
- After the system requires any servicing or routine maintenance by your local water treatment specialist.
- After long periods of time when system is not used (approximately 30 days or more)
- Whenever evidence of harmful bacteriological contamination of the system has been discovered. In this case contact your local water treatment specialist to disinfect your reverse osmosis system, and identify and eliminate the source of contamination.

IMPORTANT: This Reverse Osmosis Drinking Water System should not be used on any water supply sources that are microbiologically unsafe or of unknown quality without adequate disinfection before and/or after the system.

Materials required for Sanitization of the Reverse Osmosis Drinking Water System:

- Mild soap solution to clean various components. Soap used should be as basic as possible and not contain any fragrances or additives.
- Soft brush to assist cleaning various components. (DO NOT USE SCOURING PADS OR ANY OTHER TYPE OF INSTRUMENT THAT COULD POTENTIALLY SCRATCH THE SURFACES OF THE UNIT.)
- Measuring spoon or device.
- Household bleach, typically containing 5.25% of chlorine.
- One (1) Gallon of potable water to mix up a disinfectant solution. (DO NOT USE WATER THAT IS NOT CONSIDERED POTABLE OR IS OF A QUESTIONABLE NATURE TO MIX UP THE DISINFECTANT SOLUTION)
- Drip pan or catch basin to collect any solution or water spilled along with paper towels to cleanup any spills.
- Silicone Based Lubricant to apply to O-Rings. (DO NOT USE PETROLEUM BASED LUBRICANTS)

Available Item # 13691 - 60 gram vial (Certified ANSI/NSF 61, FDA Registration No. 21 CFR 715.300)

Other important requirements of note:

- Before beginning installation and/or sanitization procedure, make sure that all tools used are disinfected.
- Thoroughly wash hands with soap before beginning installation and/or sanitization procedure. If your hands come into contact with any unsanitary surface while performing this procedure or the installation, hands should be rewashed with soap.
- Any surfaces used to work with to set various components on to dry, should be cleaned and disinfected.
- Any replacement cartridges, membranes and cleaned components should be handled as little as possible.
- A new pair of latex or surgical type gloves may be used to perform any sanitization procedure, but also be aware that if the gloves surface comes into contact with any unsanitary surface while performing this procedure or the installation, the gloves should also be re-disinfected or replaced.

Sanitization Steps

STEP 1: TURN OFF WATER SUPPLY - CLOSE INLET SUPPLY ALL THE WAY

STEP 2: DEPRESSURIZE SYSTEM - OPEN FAUCET SUPPLY UNTIL ALL WATER IS EMPTIED

Use a clean drip pan or basin to continue to catch any spilled water remaining in the housings as you remove the membrane and cartridges.

STEP 3: (Refer to Figures 12, 13 and 14) DISCONNECT THE FEED TUBE FROM THE MEMBRANE HOUSING MODULE. UNSCREW THE MEMBRANE HOUSING MODULE END CAP AND REMOVE THE MEMBRANE ELEMENT. PUT THE MEMBRANE ELEMENT ASIDE ON A CLEAN DISINFECTED SURFACE.

(Unless the membrane element is being replaced at this time, then discard the old membrane.)

STEP 4: OPEN THE FILTER SUMPS WITH THE SUMP WRENCH SUPPLIED AND REMOVE THE CARTRIDGES.

STEP 5: CLEAN THE FILTER SUMPS WITH SOAP AND CLEAN WATER. USE A CLOTH OR SOFT BRUSH AS REQUIRED. CLEAN THE INSIDE OF THE MEMBRANE HOUSING AS WELL.

(You may need to pay close attention to the O-Ring seals and re-grease them afterwards with silicone lubricant)

STEP 6: REINSTALL THE FILTER SUMPS (EXCEPT THE 1ST PRE-FILTER SUMP) AND THE MEMBRANE CAP AND RECONNECT THE INLET TUBING TO THE MEMBRANE HOUSING CAP.

STEP 7: MIX UP A DISINFECTANT SOLUTION OF 1 TEASPOON OF 5.25% BLEACH IN 1 GALLON OF WATER.

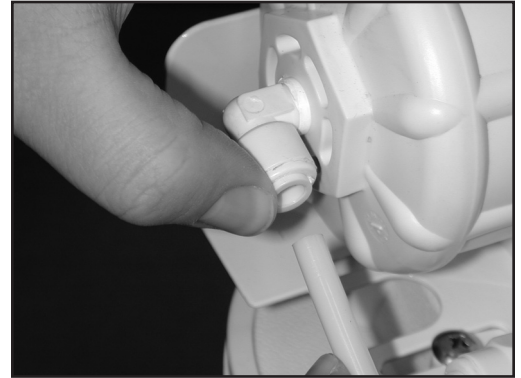

Figure 12



Figure 13



Figure 14

STEP 8: POUR THE MIXED DISINFECTANT SOLUTION INTO THE 1ST PRE-FILTER SUMP AND RE-INSTALL.

STEP 9: OPEN THE INLET VALVE AND OPEN THE FAUCET. WHEN WATER BEGINS RUNNING FROM THE FAUCET AGAIN, CLOSE THE FAUCET AND ALLOW THE PRESSURE TANK TO FILL FOR 5 - 10 MINUTES. WHEN THE PRESSURE TANK FEELS LIKE IT HAS FILLED, CLOSE THE INLET SUPPLY VALVE.

STEP 10: ALLOW THE SYSTEM TO SIT WITH THE DILUTED SANITIZING SOLUTION FOR APPROXIMATELY 20 MINUTES.

STEP 11: OPEN THE FAUCET AND PURGE THE TANK AND SYSTEM OF THE SANITIZING SOLUTION.

STEP 12: REINSTALL THE MEMBRANE AND REPLACE THE CARTRIDGES. PURGE THE PRE-CARBON CARTRIDGE OF FINES (as per installation instructions). OPEN THE INLET SUPPLY NEEDLE VALVE AND ALLOW SYSTEM TO FILL.

OPEN THE FAUCET AND DISCARD THE FIRST TANK FULL OF WATER. (IF A NEW MEMBRANE ELEMENT IS INSTALLED A THIS TIME, DISCARD THE FIRST TWO TANKS FULL OF WATER).



Figure 15



Figure 16

Reverse Osmosis Drinking Water System Maintenance Record

Installation Date: _____

Use this chart to record the dates of any cartridge changes. It is meant to assist you on keeping track of this maintenance.

#26091 WSW-05B <i>5 micron Sediment Cartridge</i>	#26081 WCB-10 <i>Carbon Cartridge</i>	#92035 and 92022 TFC RO Membrane <i>50 or 75 USGPD Rated Membrane</i>	Sanitization Procedure <i>(refer to instructions)</i>
3 sump models	3 sump models (x2)	refer to model	all models
Every 12 months	Every 24 months	24-36 months*	Every 6-12 months

* The replacement frequency of the R.O. membrane is somewhat dependent on the feed water quality. If the product water quality has decreased or the production of water had dropped off, the membrane requires replacement.

Parts List and Drawing - Models E(50 & 75) TFC-3SF

Note: There may be some parts listed, which are not included with this model.

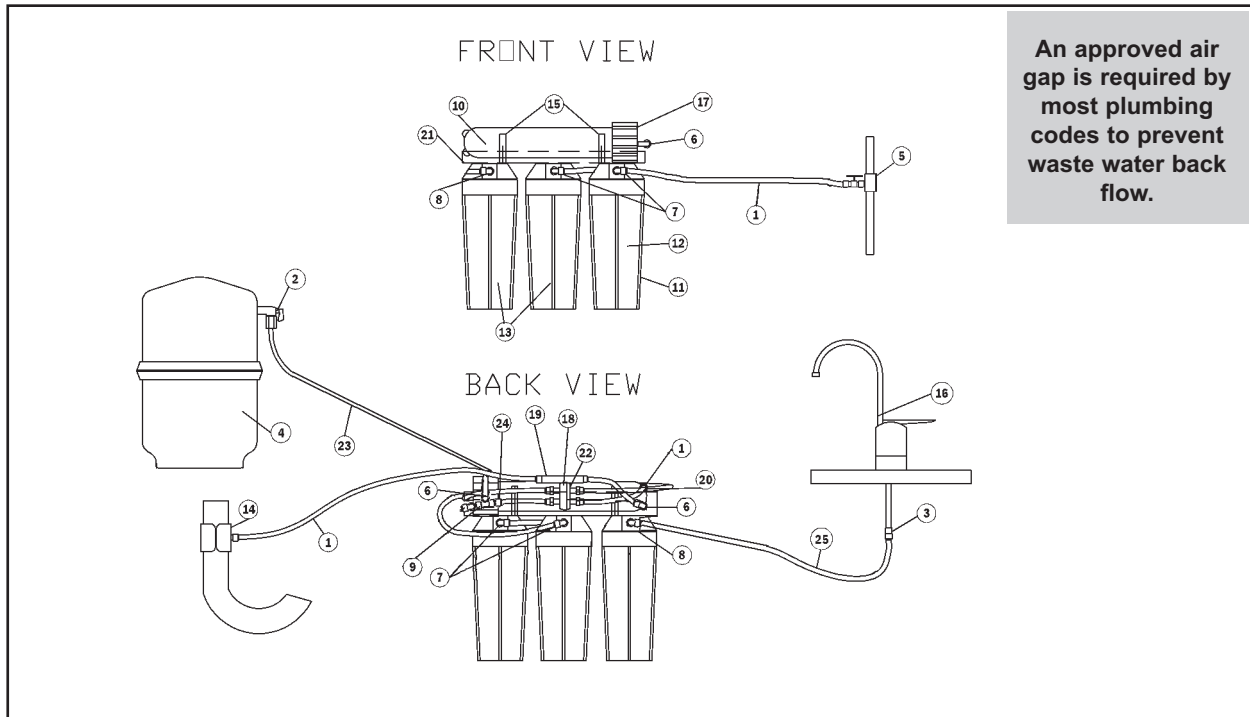

<u>Drawing No.</u>	<u>Description</u>	<u>Item No.</u>
1.....	Tubing, 1/4" OD, poly, natural	115200
2.....	Valve, 3/8", Shut Off	80704
3.....	Adapter, faucet, 3/8", QC	92407
4.....	Tank, storage, RO, 3800, white, c/w shut off	92313
5.....	Feed water adapter c/w ball valve	92469
6.....	Elbow, male, 1/4" x 1/8" npt	92406
7.....	Elbow, male, 1/4" x 1/4" npt	92405
8.....	Elbow, male, 3/8", tube, QC	92404
9.....	Tee, 3/8" x 1/4" npt	92403
10.....	Membrane, RO	
50 GPD, TFC	92035
75 GPD, TFC	92022
11.....	Housing, cartridge, white/black	92026
12.....	Cartridge, pre-filter, 5 micron	26091
13.....	Cartridge, carbon	26081
14.....	Saddle, drain, set, RO, 3/8"	92160
15.....	Clip, pipe, 2", set	92162
16.....	Faucet, standard	87511
16.....	Faucet, standard, <i>OPTIONAL WQA CERTIFIED</i>	92609
17.....	Vessel, membrane	92211
18.....	Valve, shut-off, auto	92223
19.....	Control, flow	
300 ml, RO 50 GPD	92263
400 ml, RO 75 GPD	92328
20.....	Valve, check, product water	92612
21.....	Bracket, RO, 3 housing	92279
22.....	Bracket, Shut Off, Auto	92224
23.....	Tubing, 3/8" OD, poly, natural	115207
24.....	Reducer 1/4" x 3/8" Stem x QC	92468
25.....	Tubing, 3/8" OD, poly, blue	87600

Reverse Osmosis Drinking Water System Flow Diagram (all models)

ADDITIONAL NOTES:

1. FILTER SUMP #1
- a. 3 SUMP RO MODELS: PRE-SEDIMENT
2. FILTER SUMP #2
- a. 3 SUMP RO MODELS: PRE-CARBON
3. FILTER SUMP #3-POST CARBON

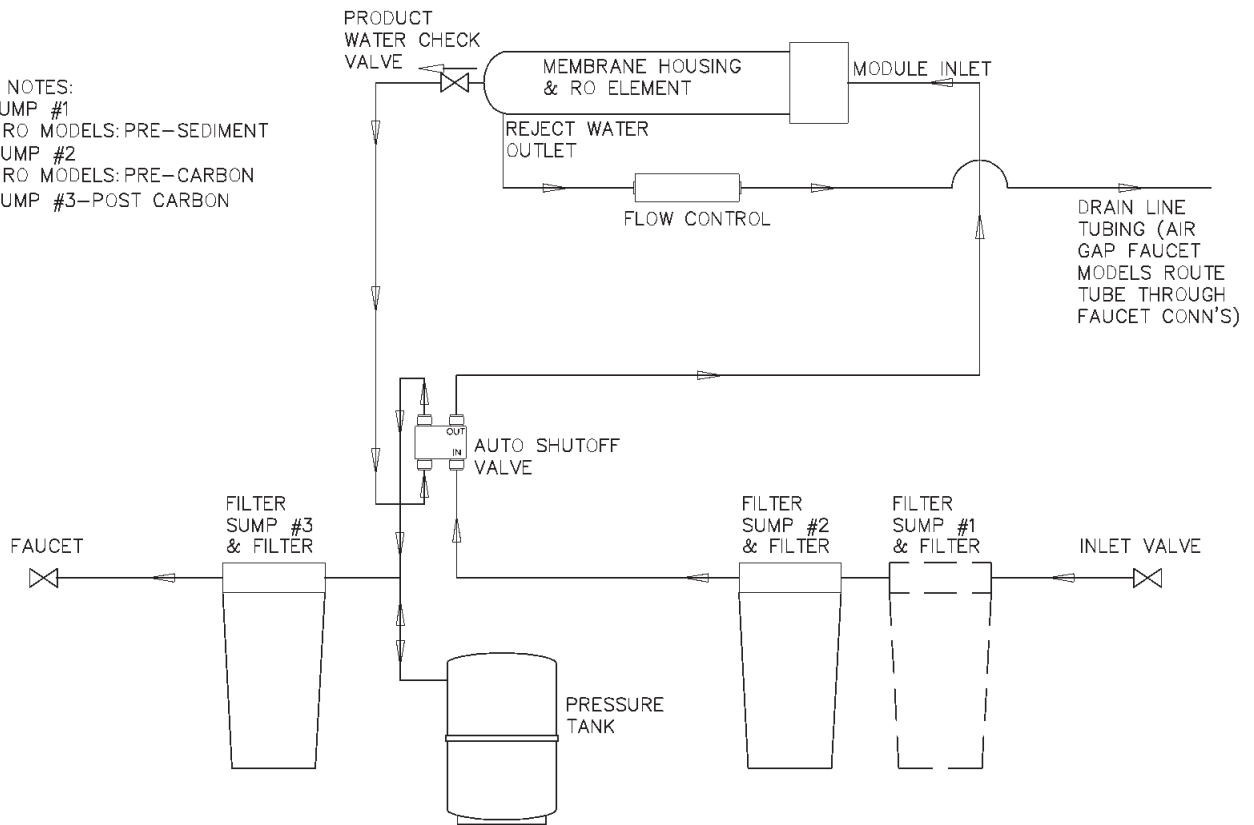

Trouble Shooting Guide

Probable Cause	Solutions
No water or not enough water	
<ol style="list-style-type: none"> 1. Feed water shut off 2. Storage tank valve shut off 3. Plugged or crimped lines 4. Pre-filter cartridge clogged 5. Low feed water pressure 	<p>Turn on feed water</p> <p>Open tank valve</p> <p>Remove blockage or crimp in lines</p> <p>Replace pre-filter cartridge</p> <p>Feed water pressure at membrane must be at least 50 psi</p>
Low flow rate from faucet	
<ol style="list-style-type: none"> 1. Low air pressure in storage tank 2. Storage tank valve partially closed 	<p>Increase air pressure to 7 psi in storage tank with product water drained</p> <p>Open tank valve completely</p>
High product water TDS	
<ol style="list-style-type: none"> 1. Insufficiently flushed filters 2. Increase in feed water TDS 3. Membrane life expired 	<p>5 gallons (approx. 2 full tanks) must be drawn from spigot to sufficiently flush filters</p> <p>Contact dealer for revised product water TDS</p> <p>Replace membrane</p>
Bad tasting water	
<ol style="list-style-type: none"> 1. Taste from glass or plastic containers 2. Post carbon filter cartridge exhausted 3. Storage tank and/or system contaminated 4. Membrane life expired 	<p>Contact dealer for explanation</p> <p>Replace post carbon filter cartridge</p> <p>Contact dealer for assistance</p> <p>Replace membrane</p>
Cloudy water	
<ol style="list-style-type: none"> 1. Dissolved air in feed water gets concentrated in product water. 	<p>Condition usually clears up eventually as feed water changes. Letting water stand will allow dissolved air to dissipate.</p>
Cloudy ice cubes	
<ol style="list-style-type: none"> 1. See cloudy water 2. Certain ice cube shapes trap dissolved air more than others. The larger, more squared off cubes are clearest, smaller rounded surface ice cubes are cloudier 	<p>See cloudy water</p> <p>Change ice cube mold shape, make cubes manually if using automatic ice cube maker, let stand to release dissolved air before freezing</p>

Reverse Osmosis Accessories

PUMPS

- 92287 BOOSTER, 6800, RO SYSTEMS UP TO 50 GPD
- 92317 BOOSTER, 8800, RO SYSTEMS UP TO 120 GPD
- 92325 BOOSTER, KEMFLO, RO SYSTEMS UP TO 75 GPD

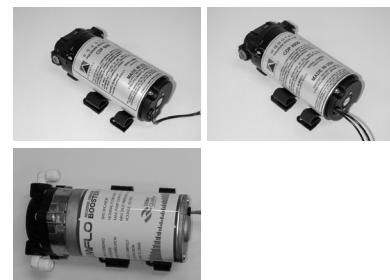

TANKS

- 92313 STORAGE, RO, PRO3800W-KFV38



FAUCETS

- 87511 LONG, REACH, STANDARD, NON AIR GAP
- 92192 LONG, REACH, C/W AIR GAP

Tomlinson Designer Series

- 87546 AIR GAP, TOMLINSON, ANTIQUE BRONZE
- 87543 AIR GAP, TOMLINSON, BISCUIT
- 87544 AIR GAP, TOMLINSON, BLACK
- 87547 AIR GAP, TOMLINSON, BRIGHT NICKEL
- 87548 AIR GAP, TOMLINSON, BRUSHED STAINLESS FINISH
- 87545 AIR GAP, TOMLINSON, POLISHED BRASS
- 87540 AIR GAP, TOMLINSON, POLISHED CHROME
- 87541 AIR GAP, TOMLINSON, SATIN NICKEL
- 87542 AIR GAP, TOMLINSON, WHITE



Tomlinson Contemporary Series

- 87553 AIR GAP, TOMLINSON, CONTEMPORARY, ANTIQUE BRONZE
- 87554 AIR GAP, TOMLINSON, CONTEMPORARY, BRUSH STAINLESS
- 87551 AIR GAP, TOMLINSON, CONTEMPORARY, POLISH CHROME
- 87552 AIR GAP, TOMLINSON, CONTEMPORARY, SATIN NICKEL

CHILLER

- 2878 CHILLER, RO, R1P



Limited Warranty

Subject to the conditions and limitations described below, WaterGroup warrants its Economy Reverse Osmosis Drinking Water Treatment Systems (excluding membrane and cartridge filters), when installed in accordance with WaterGroup specifications, to be free from defects in materials and workmanship under normal use within the operating specifications for a period of one (1) year from date of purchase (with bill of sale) or 18 months from product date code, whichever occurs first.

Other than the membrane and cartridge filters, any part found defective within the terms of this warranty will be repaired or replaced by WaterGroup. If any part is found defective, WaterGroup also reserves the right to replace the drinking water appliance with a comparable WaterGroup drinking water system of equal or greater quality. You pay only freight for repaired or replaced parts from our factory and local dealer charges, including but not limited to labor charges, travel and transportation expenses and handling fees.

This warranty shall not apply to any part damaged by accident, fire, flood, freezing, Act of God, bacterial attack, membrane fouling and/or scaling, sediment, misuse, misapplication, neglect, alteration, installation, or operation contrary to our printed instructions, or by the use of accessories or components which do not meet WaterGroup specifications. If the drinking water system is altered by anyone other than WaterGroup the warranty shall be void.

ALL IMPLIED WARRANTIES, INCLUDING WITHOUT LIMITATION WARRANTIES OF MERCHANTABILITY AND FITNESS FOR PARTICULAR PURPOSE, ARE LIMITED TO THE DURATION OF THE PERIOD SPECIFIED ABOVE FOR THE PARTS DESCRIBED IN THIS LIMITED WARRANTY.

As a manufacturer, we do not know the characteristics of your water supply. The quality of water supplies may vary seasonably or over a period of time. Your water usage may vary as well. Water characteristics can also change if the drinking water appliance is moved to a new location. For these reasons, we assume no liability for the determination of the proper equipment necessary to meet your requirements, and we do not authorize others to assume such obligation for us. Further, we assume no liability and extend no warranties, express or implied, for the use of this product with a non-potable water source or a water source which does not meet the conditions for use as described in this Owners Guide.

WATERGROUP'S OBLIGATIONS UNDER THIS WARRANTY ARE LIMITED TO THE REPAIR OR REPLACEMENT OF THE FAILED PARTS OF THE DRINKING WATER SYSTEM, AND WE ASSUME NO LIABILITY WHATSOEVER FOR DIRECT, INDIRECT, INCIDENTAL, CONSEQUENTIAL, SPECIAL, GENERAL OR OTHER DAMAGES, WHETHER FROM CORROSION OR OTHER CAUSES.

Some states do not allow limitations on how long an implied warranty lasts, so the above limitations may not apply to you. Similarly, some states do not allow the exclusion of incidental or consequential damage, so the above limitation or exclusion may not apply to you. This warranty gives you specific legal rights, and you may have other rights that vary from state to state.